

Seoul Office :
 Doosan Tower 26TH FL. 18-12, Euljiro-6Ga,
 Jung-Gu, Seoul, Korea 100-730
 Tel : +82-2-3398-8114
 Fax : +82-2-3398-8117
www.doosaninfracore.com

Doosan Infracore Europe S.A.
 1A, Rue Achille Degrace, 7080 Frameries, Belgium
 Tel : +32-65-61-3230 Fax : +32-65-67-7338

Doosan Infracore U.K., Ltd.
 Doosan House, Unit 6.3, Nantgarw Park, Cardiff CF47QU, U.K.
 Tel : +44-1443-84-2273 Fax : +44-1443-84-1933

Doosan Infracore Germany GmbH
 Hans-Böeckler strasse 29, D-40764, Langenfeld-Fuhrkamp, Germany
 Tel : +49-2173-8509-18 Fax : +49-2173-8509-45

Doosan Infracore France
 1/3 Rue Pavlov Z.I. des Bruyères 78190 Trappes-France
 Tel : +33-1-30-16-21-41 Fax : +33-1-30-16-21-44

Doosan Infracore America Corporation
 2905 Shawnee Industrial Way, Suwanee, Georgia 30024, U. S. A
 Tel : +1-770-831-2200 Fax : +1-770-831-0480

Doosan Infracore (China) Co., Ltd.
 #28, Wuzhishan Road, Eco. & Tech, Development Zone, Yantai, Shandong, China
 Tel : +86-535-638-2000 Fax : +86-535-638-2004

Doosan Infracore Xinjiang Machinery Co.,Ltd.
 No, 178, Hetanbei Road, Wurumuqi, Xinjiang, China
 Tel : +86-991-469-7217 Fax : +86-991-469-8641

Doosan Infracore Liaoning Machinery Co.,Ltd.
 No.32 DongLing Road, DongLing District, ShenYang, Liaoning, China
 Tel : +86-24-8841-1407 Fax : +86-24-8841-1404

Doosan Infracore South Africa (PTY)LTD.
 60C Electron Road, Isando 1600, Johannesburg, South Africa
 Tel : 27-11-974-2095 Fax : 27-11-974-2778

Doosan Infracore Middle East Center(Dubai)
 P.O.Box 183127, Al-Serkal Building, Air Port Road,Dubai, U.A.E
 Tel : +971-4-295-2781~2 Fax:+971-4-295-2783

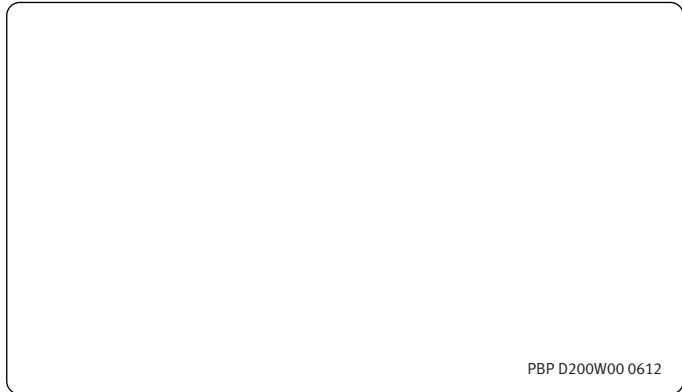

PBP D200W00 0612

The illustrations do not necessary show the product in standard version.
 All products and equipments are not available in all markets.
 Materials and specifications are subjects to change without prior notice.





Doosan Infracore
Construction Equipment

DL200

Engine Power : SAE J1995, gross 107 kW (143 HP) @ 2,100 rpm

SAE J1349, net 102 kW (137 HP) @ 2,100 rpm

Operational Weight : 11,300kg (24,912 lb) - STD.

Bucket capacity(SAE) : 1.8 ~ 2.0m³ (2.35~2.62 cu.yd)



Wheel loader : DOOSAN DL200

A Powerful Wheel loader with Novel Features



DL 200



The new DL200 wheel loader has all the advantages of the previous loaders. This logical new step provides real added value to the operator.

The key phrase used during the development of the DL200 was "giving optimal value to the end user". This translates, in concrete terms, into:

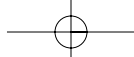

Increased production due to the use of a new generation "Common Rail" engine and the excellent synchronisation of the drive train with the hydraulics system.

Improved ergonomics, increased comfort and excellent all round visibility ensuring safe and pleasant working conditions.

Improved reliability through the use of higher performance new materials, the development of new computer-assisted structural design techniques and by intensive and systematic test programs. All of these combine to increase the life of vital components and reduce operating costs.

Reduced maintenance increases the availability of the loader and reduces operating costs.

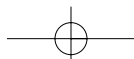

PERFORMANCE

Perfect integration of power and intelligence.

When exceptional power is combined with the very best workmanship, the wheel loader reaches the peak of its performance.

The DL200 loader gives you outstanding productivity. The reason is, on the one hand, the impressive digging power allows the hardest materials to be tackled and, and on the other, high tractive power enables easy penetration.

With a powerful hydraulic system, the operator can work quickly and powerfully.

At the heart of the loader is the new DOOSAN DLo6 "Common Rail" engine.

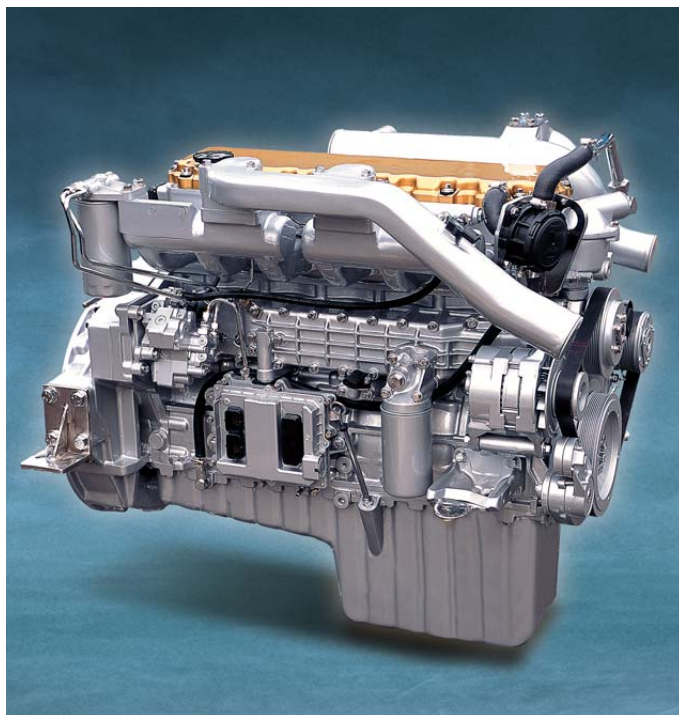

DOOSAN DLo6 "Common Rail" engine

The engine features excellent power and torque characteristics. With 4 valves per cylinder and electronic control, combustion is optimised and reduced emissions minimize pollution.

Increased torque and a generous torque reserve allow efficient use of power by the hydraulic system.

High torque means high manoeuvrability of the loader when moving.

The engine has two modes of operation: "power" or "economy".

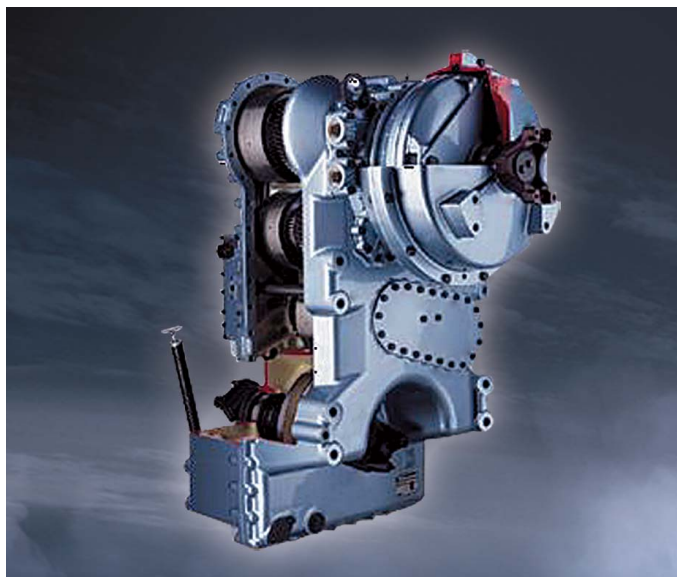

Automatic transmission

The transmission is particularly smooth and the gear ratios are optimised.

There are no shocks, resulting in an appreciable level of comfort for the operator. The traction force is optimum under all working conditions.

The combination of these characteristics enables the loader to maintain high speed under all conditions and favours penetration and thus optimum bucket filling at each cycle.

The transmission has three modes of operation:

- Manual
- Automatic (automatic shift for all gears)
- Semi - Automatic (automatic with a "kick down" for first gear)

DOOSAN Infracore is aware of the importance of protecting the environment.

Ecology was uppermost in the minds of the research workers right from the start of the design of the new machines. The new challenge for the engineers is to combine the protection of nature with equipment performance. DOOSAN has been investing heavily to this end.

The new DOOSAN DLo6 engine respects and protects the environment, limiting all types of toxic emissions.

DL 200

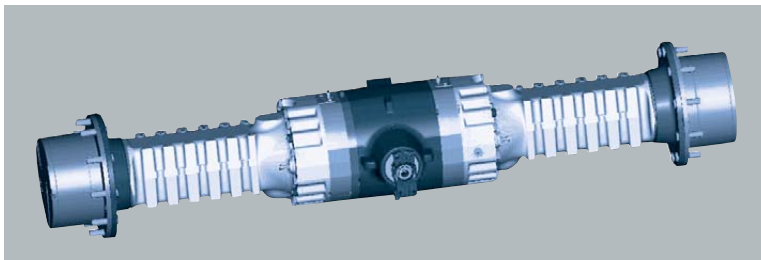

Limited slip differential (option)

The machine's axles are fitted with limited slip differentials at the front and rear. This automatically ensures the maximum tractive effort and easy driving over soft and muddy ground. It also reduces the risk of skidding and, at the same time, prevents excessive tyre wear.



Z kinetics

The Z lifting geometry is very robust and especially designed for heavy loads. Few moving parts, reduced loads, simplicity, ... everything contributes to good loader stability. This geometry enables very rapid bucket movements and ensures correct angle positioning in all situations. The rapid bucket dump capability makes it easier to unload adhesive materials.

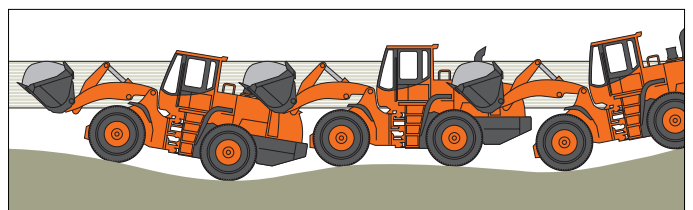

Load stabilizer (option)

This system is ideal for all loading and movement situations and increases driver productivity and comfort. It also minimises the amount of material spilt during travelling.



Hydraulic Power Steering

The newly designed steering system ensures smooth steering even in the low engine speed ranges.

- Steering control valve

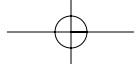

COMFORT

A perfect workspace has been created for you.

The work rate of the wheel loader is directly linked to the performance of its operator.

DOOSAN designed the DL200 by putting the operator at the centre of their development goals.

More space, better visibility, air conditioning, a very comfortable seat, sufficient storage space...

All these elements ensure that the operator can work for hours in excellent conditions.



Visibility

Visibility has been improved in all directions and the size of the cab has been increased.

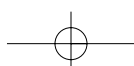

DL200

**Air conditioning**

The high performance air conditioning system provides an air flow which is adjusted and electronically controlled according to the conditions. A double air filter protects the operator's environment. The comfort is comparable to that of a new car.

**Steering column**

The steering column features both tilting and telescopic functions.

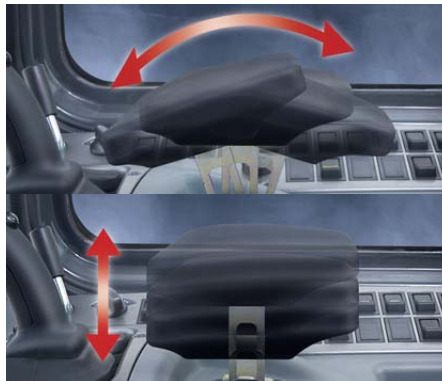
**Arm rest**

Correct positioning with clear controls makes the operator's task easier.

**Control levers (option)**

The control levers are very precise. Different options are available to match what the operator is accustomed to as well as an optional auxiliary lever.

**Lateral console**

The control console is thoughtfully placed to the right of the operator. Provision is provided to fit switches for additional equipment if required.

**Central indicator panel**

A high visibility indicator panel allows the operator to check essential loader functions.

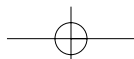
**Sunvisor & Room mirror(Std.)**

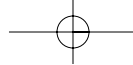

MAINTENANCE

Short, simple maintenance operations at long intervals increase the availability of the equipment on site. DOOSAN has developed the DL200 with a view to high profitability for its user. A detailed design of each detail guarantees optimum reliability and reduced maintenance costs.



Hydraulic circuit return filter

The hydraulic circuit return filter, made of glass fiber, eliminates up to 99.5% of foreign substances. It effectively protects the hydraulic circuit and extends service intervals.



Central joints

The central joints of the machine are particularly robust. The attachment points are positioned to withstand bending and torsion forces. A large amount of space has been left to allow easy access to internal components.



Transmission filter

The transmission filter is easy to reach and can, like all other maintenance components, be checked from ground level.



Air cleaner

The forced air cleaner removes 99.9% of particles. It is preceded by a high capacity pre-filter. The cleaning and cartridge replacement intervals are very long.



Reversible fan

The radiator fan has a reversible flow capability to make cleaning of the coolers easier when the machine is operating in dusty environments.



Brake & Pilot Filter

The pilot filter is easy to replace and a clogged filter warning system has been added for extra protection.



Greasing Lubrication Ports

The front pins can be lubricated from the outside of the machine without crawling under the machine or in awkward positions through the lubrication ports.



Convenient Transmission Oil Filling

The oil filler pipe is located near the articulation joint for easy access.

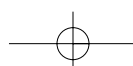

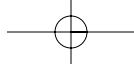

DL200



Hydraulic pressure check points
The pressure test points are grouped together. (Main pressure, steering, braking etc).



Transmission diagnostics
The transmission and engine can be diagnosed using a laptop computer to interface with the diagnostic system.



Engine oil and coolant drains
Drains are installed in very accessible places to facilitate emptying without the risk of polluting the environment.



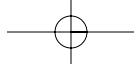

RELIABILITY

DL200

Because the operator knows that the DOOSAN loader is a tough, reliable, product with large power reserves, it can be relied on to work for long periods.

For DOOSAN, reliability means above all durability, availability, accessibility and simplicity.

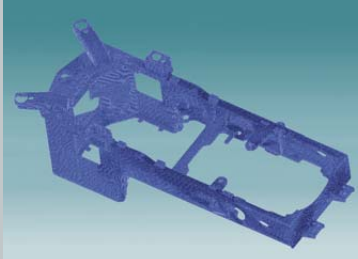
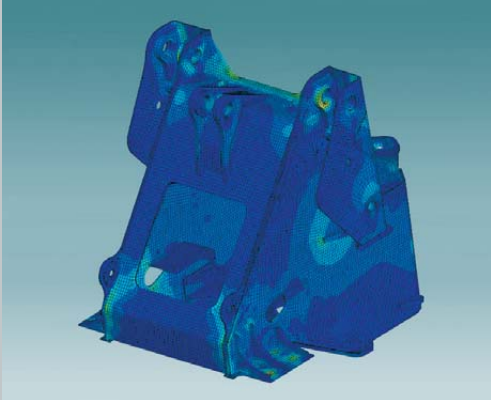

Special attention was given to the design and manufacture of structural components.

To ensure long lifetime for the main structures, DOOSAN has used finite element techniques. All the structural components such as the chassis, the joints and the lifting arm have been designed using this method. After modelling, they are subjected to intensive laboratory and field testing where extreme conditions are simulated and tested. Statistical data is established in order to constantly increase the level of reliability.

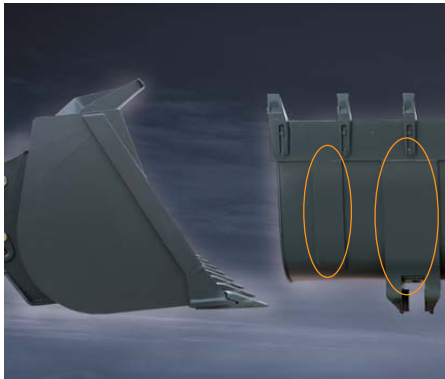

Reinforced bucket
The bottom of the bucket are reinforced.



Radiator grill
The radiator grill is made from reinforced steel for increased shock resistance.

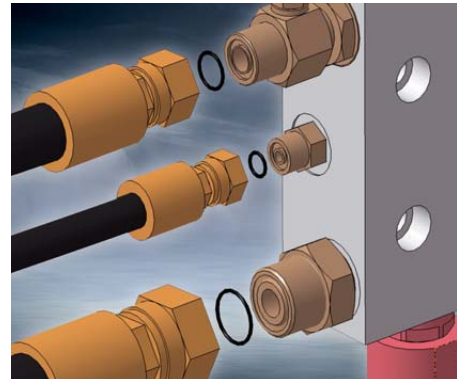

ORFS
To ensure perfect oil tightness, all ports, even the low pressure ports which are used for the pilot lines, are ORFS type.

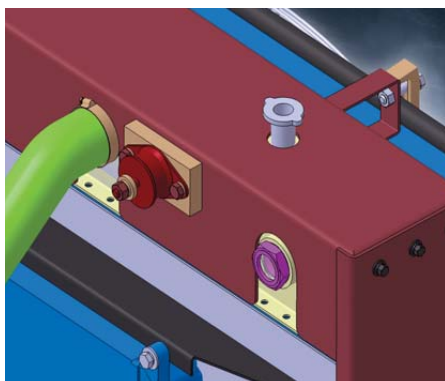

Radiators mounted on rubber mounts
The aluminium radiators are mounted on rubber mounts to effectively withstand vibrations.

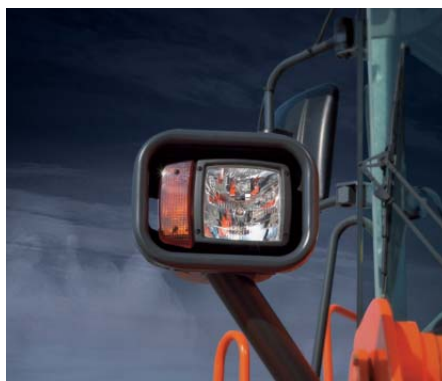

Front combination lamp
With the application of high-grade Hella products, the lamp life has extended much more.



Rear combination lamp
A semi-permanent lamp life has been secured with the application of LED-type stop and position lamps.

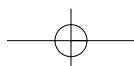

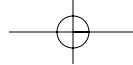

STANDARD AND OPTIONAL EQUIPMENT

* STANDARD EQUIPMENT

■ Engine

- Three stage air cleaner with cyclone precleaner, inner filter, and external filter restriction indicator as at the dashboard
- Fuel filter with water separator
- Fuel filter
- Hydraulically driven fan with bi-direction flow for core cleaning
- External drains for engine oil and coolant changes
- Engine power Mode selector switch (Standard / Economy mode)
- Self-diagnosis function

■ Lifting and Hydraulic system

- Robust Z bar lifting system
- General purpose bucket 1.9 m³ (SAE,heaped)
- Mono control lever
- Hydraulic control valve with two sections
- Automatic boom kick out
- Automatic bucket return to dig.
- Fast couplers for hydraulic check

■ Steering system

- Load sensing orbitrol type steering control, full hydraulic, power steering

■ External equipments

- Lifting hooks
- Articulation lock in the transport position
- Towing hitch
- Tool compartment
- Wheel chocks
- Semi-fender

■ Electric System

- Alternator 60A / 24V
- Working lights: 2 at the front and 4 at the rear (6 x 70 W)
- Driving lights: low and high beams
- Tail indicators, stop, reversing lights
- Reversing alarm

■ Drive line and Brake system

- Transmission which can be declutched when braking
- Transmission with self diagnosis and monitoring indicator, plus electronic plug for fast adjustment
- Transmission Mode selector switch (Manual / Auto 1 4 / Auto 2 4)
- Starting safety system
- Travel direction and kickdown selection lever at left of the steering wheel and on the joystick
- Dual brake circuits with accumulator
- Tyres 20.5-25-12PR(L2)
- Dual service brake pedals
- Parking brake on front axle, spring applied hydraulic release

■ Cab

- Air-conditioning / heating with recirculation function
- Double Filtered air cab
- Mechanical seat with 2" safety belt & telescopic)
- Compartment for cans
- Floor mat
- Tinted glasses
- Left sliding window
- Front and rear wiper
- Front and rear washers
- Sun visor
- Interior cab light
- Interior rear view mirror (2)
- Heated Exterior rear view mirrors (2)
- Machine monitoring (condition, control & maintenance indicators in front of the driver by dials, gauges and lamps)
- Switches for the general functions in the right console
- Electrical horn
- Cigarette lighter
- 12 Volt power socket
- Cup holder
- Compartment for shoes
- Radio antenna built into rear window
- Speakers & connection for radio
- ROPS cabin (Rollover Protective Structure); ROPS meets the following criteria: SAE J 394, SAE 1040, ISO 3471
- FOPS cabin (Falling Objects Protective Structure); FOPS meets the following criteria: SAE J 231, ISO 3449

* OPTIONAL EQUIPMENT

Some of these optional equipments may be standard in some markets. Some of these optional equipments cannot be available on some markets.

You must check with the local DOOSAN dealer to know about the availability or to release the adaptation following the needs of the application.

■ Ground Engaging Tools

- Various types of buckets, fork palette, timber grapples and accessories

■ Tyres

- L2, L3, L5 following various types of manufacturers

■ Lifting and Hydraulic system

- Hydraulic control valve with 3 sections
- FNR mono lever with 3rd function lever for third section
- Two hydraulic levers for 2 sections with FNR function
- Three hydraulic levers for 3 sections with FNR function
- Hydraulically driven fan with adjustable speed proportional to fluid temperature
- Load isolation system (LIS)

■ Electric system

- Rotating beacon
- Fuel heater

■ Cab

- Rear camera (CCTV) and monitor
- CD MP3 player

■ Various

- Tool Kit

■ External equipments

- Full fenders
- Lower protection plates
- Boom float kick-out
- Additional counter weight

■ Steering system

- Emergency steering pump driven by electric motor

■ Driven line and Brake system

- Limited slip differentials on front and rear axles

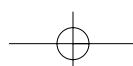

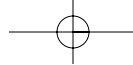

TECHNICAL SPECIFICATIONS

* ENGINE

• Model

Doosan DLo6
 "Common Rail" engine with direct fuel injection and electronic control, 4 valves per cylinder, vertical injectors, water cooled, turbo compressor and air-air cooling of the intake air. The emission levels are well below the values required for Phase III. Two modes available: normal and economy.

• Number of cylinders

6

• Rated power

107 kW(143 HP) @ 2,100 rpm (SAE J1995, gross)
 102 kW(137 HP) @ 2,100 rpm (SAE J1349, net)

• Maximum power

118 kW(158 HP) @ 1,800 rpm (SAE J1995, gross)
 113 kW(152 HP) @ 1,800 rpm (SAE J1349, net)

• Maximum torque

70 kgf.m (686 Nm) at 1,400 rpm

• Piston displacement

5,900 cc (360 cu.in)

• Bore & stroke

100 mm x 125 mm (3.9" X 4.9")

• Starter

24 V / 4.5 kW

• Batteries

2 x 12 V / 100 Ah

• Air cleaner

Double element and pre-filtered with auto dust evacuation.

• Cooling

The hydraulic motor fan direction is reversible to facilitate cleaning.

The speed of rotation is automatically adjusted according to the temperature conditions encountered.(option)

* TRANSMISSION

The "Power Shift" transmission can be used in manual mode, fully automatic or semi-automatic with the "kick down" function.

This transmission is based on components of excellent reputation. It is equipped with a modulation system designed to protect it and ensure smooth gear and direction changes.

A manual transmission control lever is located to the left of the operator. In automatic or semi-automatic mode a change of direction function is also available.

The transmission can be disengaged by the brake pedal to make all the engine power available for the hydraulics. A safety device prevents the engine being started if the transmission is not in neutral. The transmission can be tested and adjusted with special equipment. A computer can be connected to monitor the history of its operation.

• Gearbox

ZF 4 WG 160

• Torque converter

Simple stage / mono phase

• Movement speed, kph

Forward: 6.6 - 12.1 - 22.6 - 35 (1 - 2 - 3 - 4)

Reverse: 7.2 - 13.0 - 25.0 (1 - 2 - 3)

• Maximum traction

11.6 tonnes

* LIFTING SYSTEM

The type Z lifting system has a simple lifting piston system and is designed for the toughest jobs. The breakout force of 10.5 tonnes combines with a Bucket angle that is well maintained throughout the range of movement. The bucket angles are optimised in the travelling position and at ground level.

The load isolation system (LIS) is fitted as option. It increases operator comfort and improves output.

• Lifting cylinders (2)

Bore x stroke: 120 mm x 798 mm(4.7" x 2'7")

• Bucket cylinders (1)

Bore x stroke: 140 mm x 495 mm(5.5" x 1'7")

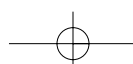

* AXLES

• Model DANA

The front and rear drive axles are fully suspended and hermetically sealed final drives and wet disc brakes.

A traction power of 11.6 tonnes allows inclines with a slope of 58% to be tackled.

• LSD differential (front and rear)- option

45%

• Oscillation angle

+/- 11°

• Brakes

Dual multi-disc circuit.

The braking system is activated by a pump and accumulator circuits.

The parking brake consists of a disc mounted on the front axle applied by a spring and released hydraulically.

* HYDRAULIC SYSTEM

The hydraulic system consists of gear type pump with steel case and automatic wear compensation.

Automatic functions for positioning the bucket for digging as well as stopping the boom at the desired height position are standard.

A simple levelling function is also available as standard.

The hydraulic control valve has a third port for powering an auxiliary hydraulic function.

• Main pumps

Triple gear pump

• Maximum flow

88 / 88 / 32 ℓ /min (23.2 /23.2 /8.5 gal/min)

• Operating pressure

204 kgf/cm² (200 bar)

• Pilot system

Automatic functions for positioning the bucket for digging as well as for stopping the boom at the desired height position are standard.

A simple levelling function is also standard.

• Filters

In the oil return to the tank, the glass fibre filter has a filtering capability of 10 micron.

• Loading cycle

Lifting speed(loaded)	5.8 seconds
Dumping speed(loaded)	1.1 seconds
Lowering speed(empty)	4.1 seconds

* CAB

The modular cab gives excellent visibility in all directions.

The driving position provides an excellent view of the bucket, the tyres and the loading area.

The ventilation is optimum. The air conditioning and heating are controlled by pushbuttons with an air recirculation function.

A double cab air filter is installed in the cab and a slight overpressure effectively protects the operator in dusty and polluted environments.

The cab is mounted on viscous suspension mounts for maximum comfort. The high quality seat is equipped with air suspension.

The cab is spacious and has generous amounts of storage.

All information necessary for operating the machine is displayed in front of the operator. The control functions are centralised on a console on the right.

Seat and arm rests are adjustable according to the operator.

The same applies for the steering column.

• Number of doors

1

• Emergency exits

2

• Standards

ROPS ISO 3471 and FOPS: ISO 3449

• Guaranteed external noise level (2000/14/EC)

104 dB(A)

• Sound level in cab. (ISO 6396)

73 dB(A)

* STEERING SYSTEM

The steering system is electro-hydraulic load sensitive type.

• Steering angle

40°

• Oil flow

88 ℓ /min (23.2 US gpm, 19.4 lmp gpm)

• Operating pressure

179 kgf/cm² (175 bar)

• Steering cylinders (2)

Bore x stroke: 70 mm x 370 mm (2.8" x 1'3")

Emergency steering system with hydraulic pump driven by an electric motor.

• Refill capacities

Fuel tank: 243 ℓ (64.2 US gal, 53.5 lmp gal)

Cooling system: 40 ℓ (10.6 US gal, 8.8 lmp gal)

Engine oil: 27 ℓ (7.1 US gal, 5.9 lmp gal)

Front axle: 19.4 ℓ (5.1 US gal, 4.3 lmp gal)

Rear axle: 18.4 ℓ (4.9 US gal, 4.0 lmp gal)

Gearbox and converter: 30 ℓ (7.9 US gal, 6.6 lmp gal)

Hydraulic system: 115 ℓ (30.4 US gal, 25.3 lmp gal)

OPERATIONAL DATA

Loader type		Z-bar (DL200)				Parallel (DL200TC)	
Configuration	Unit	Teeth (BOT)	Teeth(std.) (BOT)	Bolt-on edges (BOC)	Bolt-on edges (BOC)	Teeth (BOT)	Bolt-on edges (BOC)
Capacity heaped ISO/SAE	m ³	1.8	1.9	1.9	2.0	1.9	2.0
	yd ³	2.4	2.5	2.5	2.6	2.5	2.6
Tooth type		Integrated tooth	Integrated tooth	-	-	Integrated tooth	-
Bucket width	mm	2,470	2,550	2,470	2,550	2,550	2,550
	ft in	8'1"	8'4"	8'1"	8'4"	8'4"	8'4"
Breakout force	ton	10.5	10.5	10.5	10.5	10.5	10.5
	lbf	23,149	23,149	23,149	23,149	23,149	23,149
Static tipping load (at straight)	kgf	8,635	8,870	8,554	8,786	8,660	8,579
	lb	19,037	19,555	18,858	19,370	19,092	18,913
Static tipping load (at 40°)	kgf	7,354	7,560	7,283	7,487	7,450	7,381
	lb	16,213	16,667	16,056	16,506	16,424	16,272
Dump height (at 45°) ¹ (at fully raised)	mm	2,730	2,730	2,800	2,800	2,650	2,719
	ft in	8'11"	8'11"	9'2"	9'2"	8'8"	8'11"
Dump reach (at 45°) ¹ (at fully raised)	mm	1,100	1,000	1,050	990	990	930
	ft in	3'8"	3'3"	3'5"	3'1"	3'3"	3'1"
Dump height (at max. dump) ¹ (at max. reach)	mm	690	730	784	823	748	843
	ft in	2'3"	2'5"	2'7"	2'8"	2'5"	2'9"
Dump reach (at max. dump) ¹ (at max. reach)	mm	1,220	1,080	1,205	1,066	705	716
	ft in	4'	3'7"	3'11"	3'6"	2'4"	2'4"
Digging depth	mm	70	90	70	90	98	98
	ft in	3"	4"	3"	4"	4"	4"
Height at bucket pivot point	mm	3,765	3,830	3,765	3,830	3,813	3,813
	ft in	12'4"	12'7"	12'4"	12'7"	12'6"	12'6"
Max. tilt angle at carry position	G degree	47	47	47	47	45	45
Max. tilt angle at fully raised	H degree	63	63	63	63	51	51
Max. tilt angle on ground	I degree	41	41	41	41	44	44
Max. tilt angle at max. reach	J degree	63	63	63	63	41	41
Max. dump angle at max. reach	K degree	77	77	77	77	90	90
Max. dump angle on ground	L degree	64	65	64	65	68	68
Max. dump angle at fully raised	M degree	49	49	49	49	46	46
External radius at tyre side	mm	5,210	5,210	5,210	5,210	5,210	5,210
	ft in	17'1"	17'1"	17'1"	17'1"	17'1"	17'1"
External radius at bucket edge	mm	5,565	5,610	5,526	5,570	5,635	5,595
	ft in	18'3"	18'5"	18'2"	18'3"	18'6"	18'4"
Wheel basis	mm	2,900	2,900	2,900	2,900	2,900	2,900
	ft in	9'6"	9'6"	9'6"	9'6"	9'6"	9'6"
Width at tyres	mm	2,374	2,460	2,374	2,460	2,460	2,460
	ft in	7'9"	8'1"	7'9"	8'1"	8'1"	8'1"
Tread	mm	1,930	1,930	1,930	1,930	1,930	1,930
	ft in	6'4"	6'4"	6'4"	6'4"	6'4"	6'4"
Ground clearance	mm	380	445	380	445	445	445
	ft in	1'3"	1'6"	1'3"	1'6"	1'6"	1'6"
Overall length	mm	7,261	7,285	7,166	7,190	7,335	7,240
	ft in	23'10"	23'11"	23'6"	23'7"	24'1"	23'9"
Overall height	mm	3,175	3,240	3,175	3,240	3,240	3,240
	ft in	10'5"	10'8"	10'5"	10'8"	10'8"	10'8"
Tyre size		17.5-25-12PR(L2)	20.5R25 VKT(L2)	17.5-25-12PR(L2)	20.5R25 VKT(L2)	20.5R25 VKT(L2)	20.5R25 VKT(L2)
Operating weight	kg	11,300	11,645	11,381	11,726	11,580	11,661
	lb	24,912	25,673	25,091	25,851	25,530	25,708

Measured to the tip of the bucket teeth or bolt-on edges.

DIMENSIONS

DL200

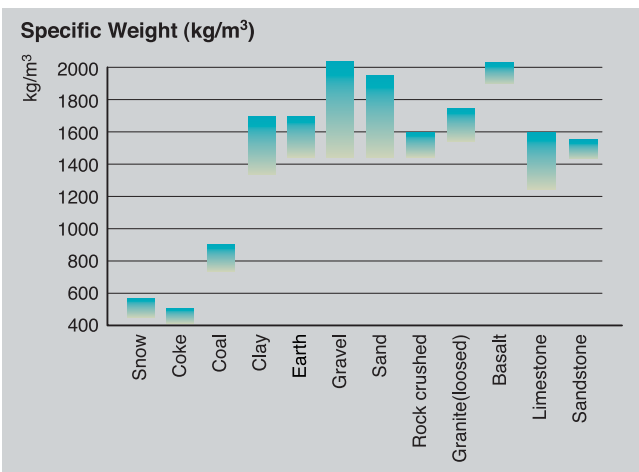
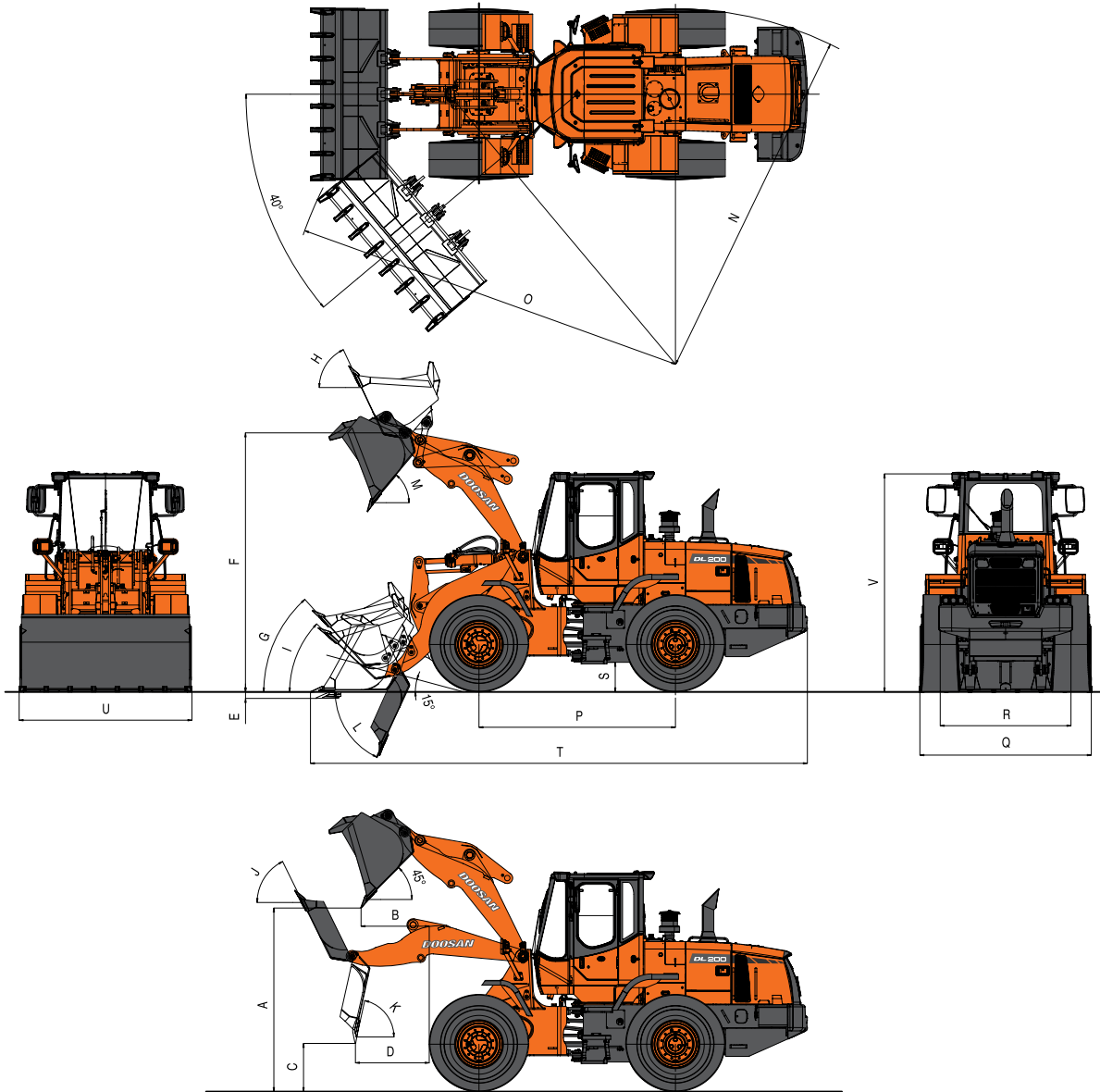

The specific weight of material largely depends on moisture rate, compacting value, percentage of various components etc... This chart is given only for information.

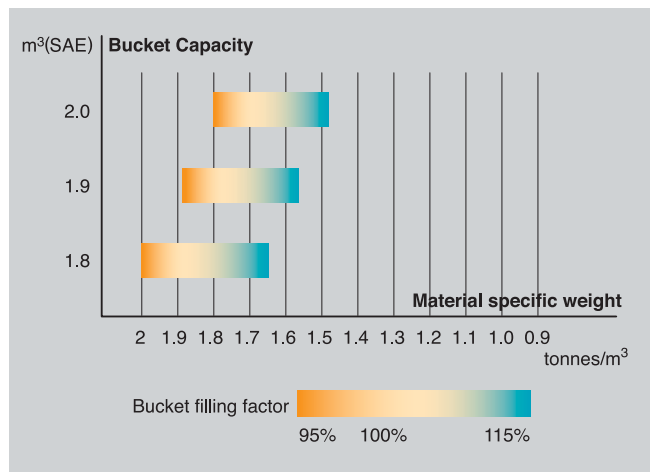

The Bucket filling factor depends also of the nature of material, the working conditions and the operator ability.